

## Specifications

Nominal Voltage		12 V
Capacity (25°C)	20HR(10.5V)	26 Ah
	10HR(10.5V)	24.2Ah
	1HR(9.60V)	16.3Ah
Dimension	Length	165 ± 2mm (6.50inch)
	Width	176 ± 2mm (6.93inch)
	Height	127 ± 2mm (5.00inch)
	Total Height	127 ± 2mm (5.00inch)
Approx. Weight		7.9kg (17.4lbs) ± 4%
Terminal type		T3/T8
Internal resistance (Fully charged, 25°C)		Approx. 12m Ω
Capacity affected by temperature (20HR)	40°C	102%
	25°C	100%
	0°C	85%
	-15°C	65%
Self-discharge (25°C)	3 month	Remaining Capacity: 91%
	6 month	Remaining Capacity: 82%
	12 month	Remaining Capacity: 65%
Nominal operating temperature		25°C ± 3°C (77°F ± 5°F)
Operating temperature range	Discharge	-15°C ~ 50°C (5°F ~ 122°F)
	Charge	-10°C ~ 50°C (14°F ~ 122°F)
	Storage	-20°C ~ 50°C (-4°F ~ 122°F)
Float charging voltage(25°C)		13.60 to 13.80V Temperature compensation: -18mV/°C
Cyclic charging voltage(25°C)		14.50 to 14.90V Temperature compensation: -30mV/°C
Maximum charging current		7.8A
Terminal material		Copper
Maximum discharge current		390A(5 sec.)
Designed floating life(20°C)		8~10years

- ◆ Absorbent glass mat technology;
- ◆ Recognized by UL & CE;
- ◆ ABS container.

## Constant Current Discharge Characteristics (A, 25°C)

F.V/TIME	10min	15min	30min	60min	2h	3h	4h	5h	8h	10h	20h
9.60V	60.0	47.5	26.5	16.3	9.24	6.63	5.30	4.51	2.92	2.45	1.32
9.90V	58.2	46.4	26.0	16.0	9.18	6.59	5.27	4.48	2.90	2.44	1.31
10.2V	55.8	44.7	25.2	15.6	9.10	6.55	5.24	4.45	2.88	2.43	1.31
10.5V	53.4	43.1	24.6	15.3	8.96	6.50	5.20	4.42	2.86	2.42	1.30
10.8V	50.4	40.9	23.7	14.8	8.74	6.31	5.04	4.29	2.77	2.37	1.27

## Constant Power Discharge Characteristics (Watt, 25°C)

F.V/TIME	10min	15min	30min	60min	2h	3h	4h	5h	8h	10h	20h
9.60V	677	542	304	188	108	78.8	63.2	53.8	35.0	29.5	15.8
9.90V	656	529	298	185	107	78.3	62.8	53.5	34.8	29.3	15.8
10.2V	629	509	289	181	106	77.8	62.4	53.1	34.6	29.2	15.7
10.5V	602	492	282	177	105	77.2	61.9	52.8	34.3	29.0	15.6
10.8V	569	466	271	172	102	74.9	60.1	51.2	33.3	28.4	15.3

Note: The above characteristics data can be obtained within three charge/discharge cycles.

## MM1226(12V26Ah)



## Dimensions

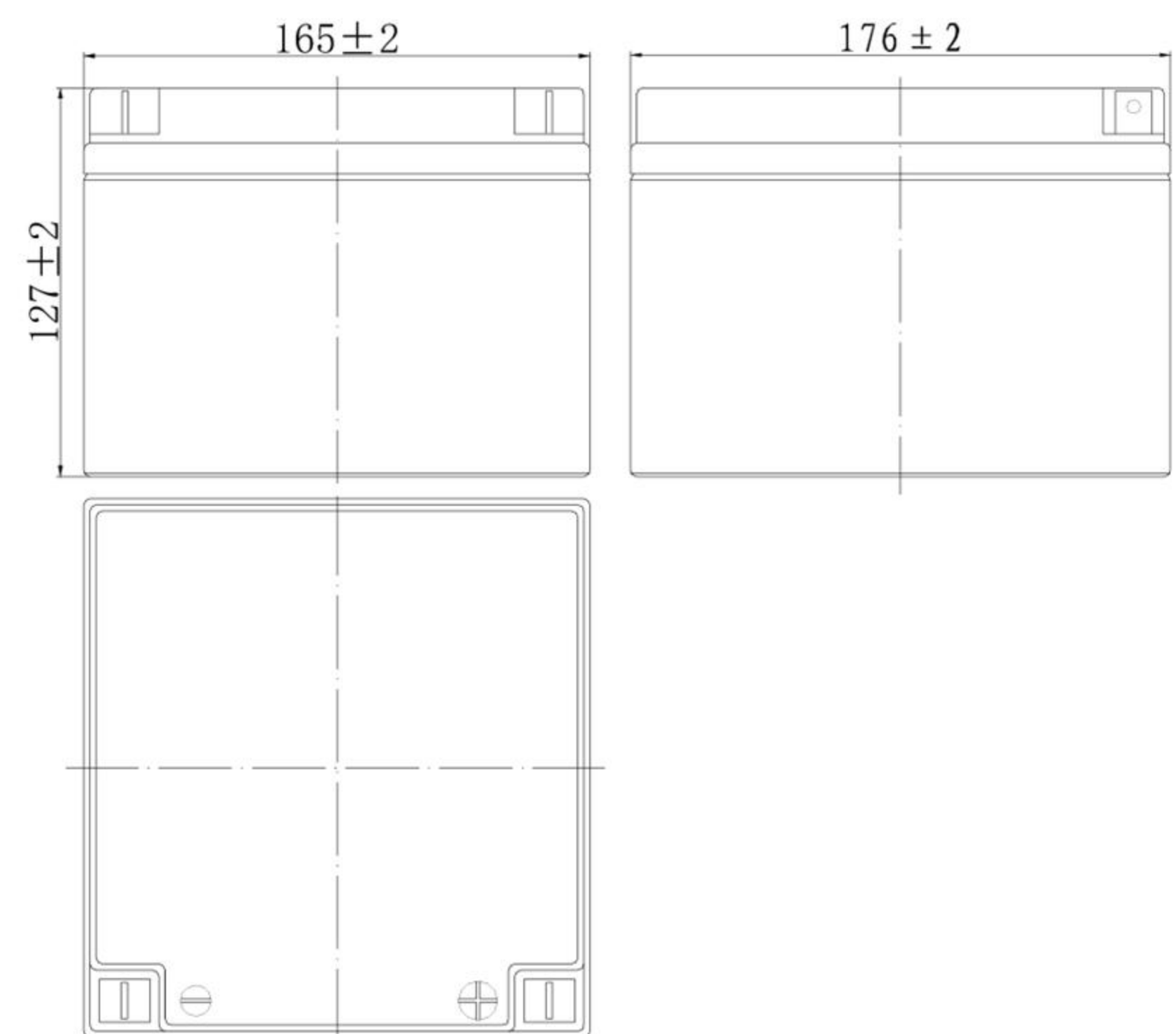

## Terminal

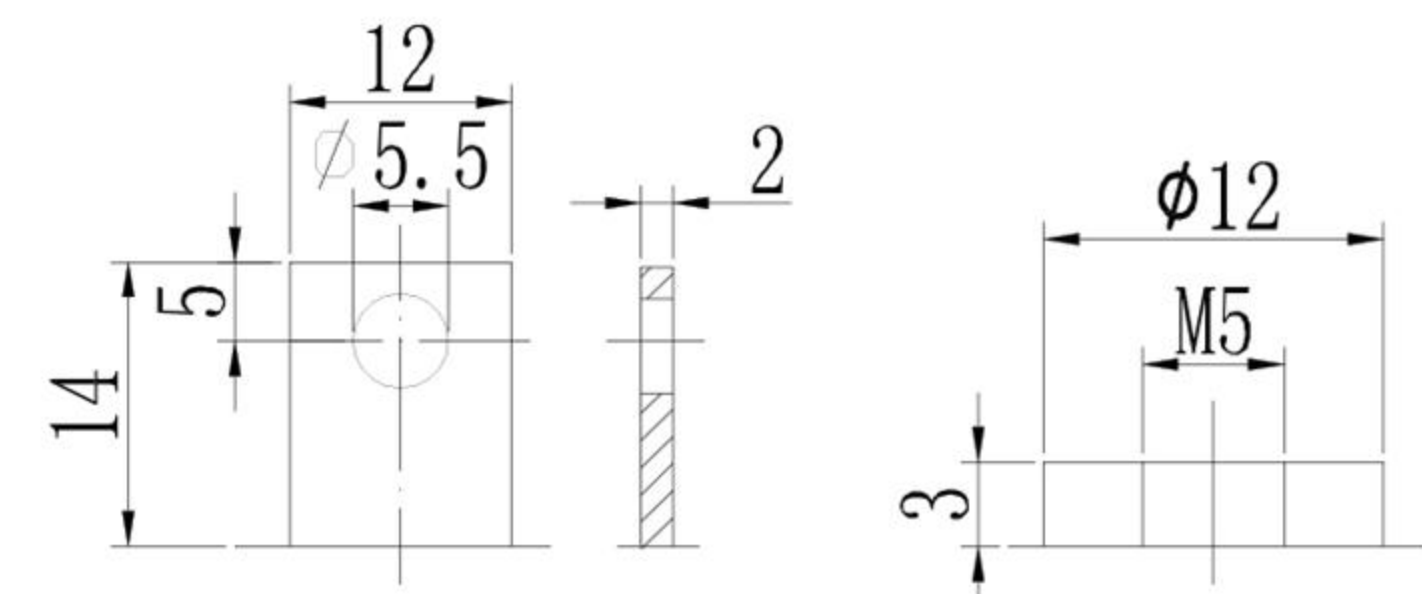

Terminal T3

Terminal T8



### Discharge Characteristics(25°C)

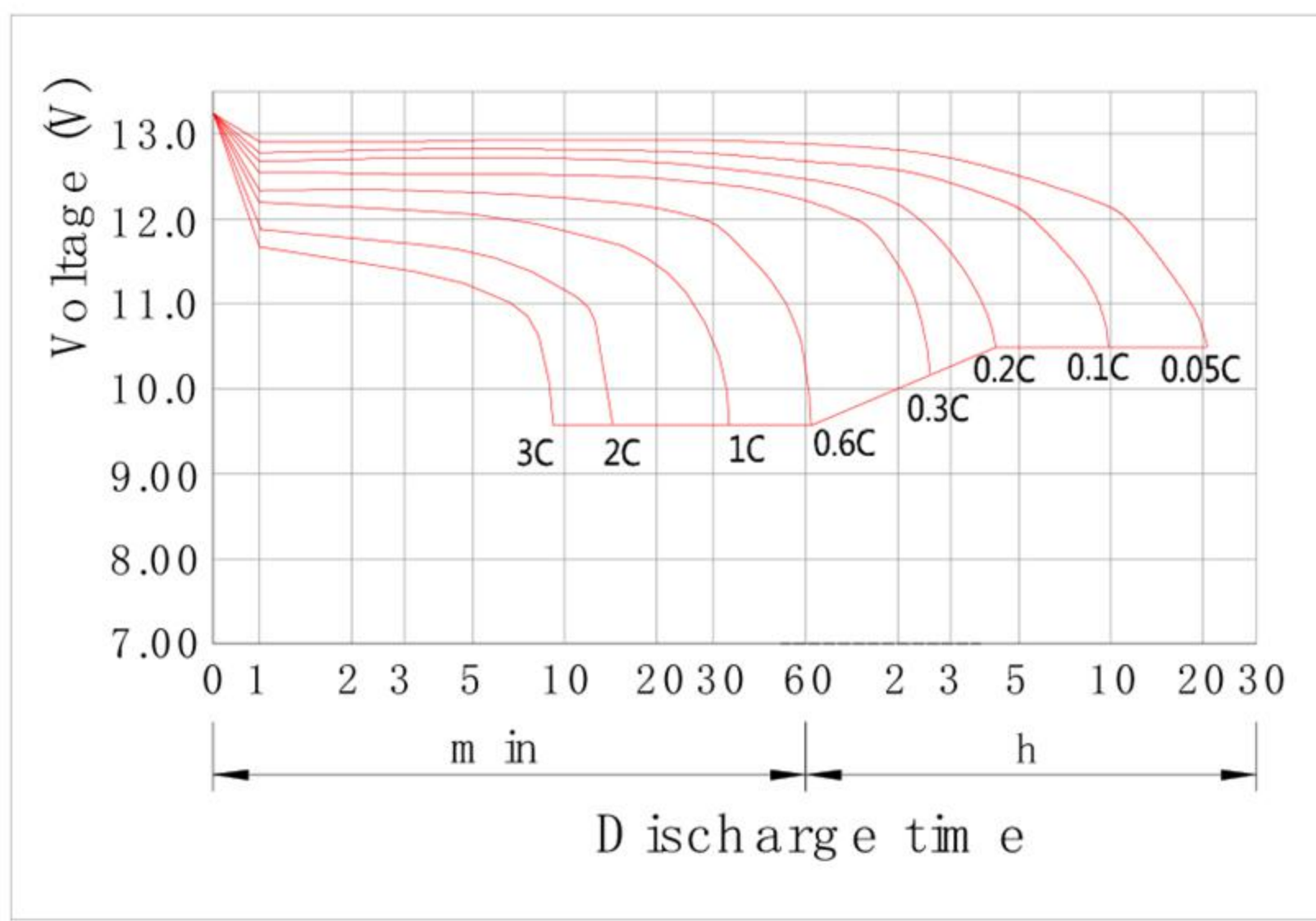

### Charging Characteristics(25°C)

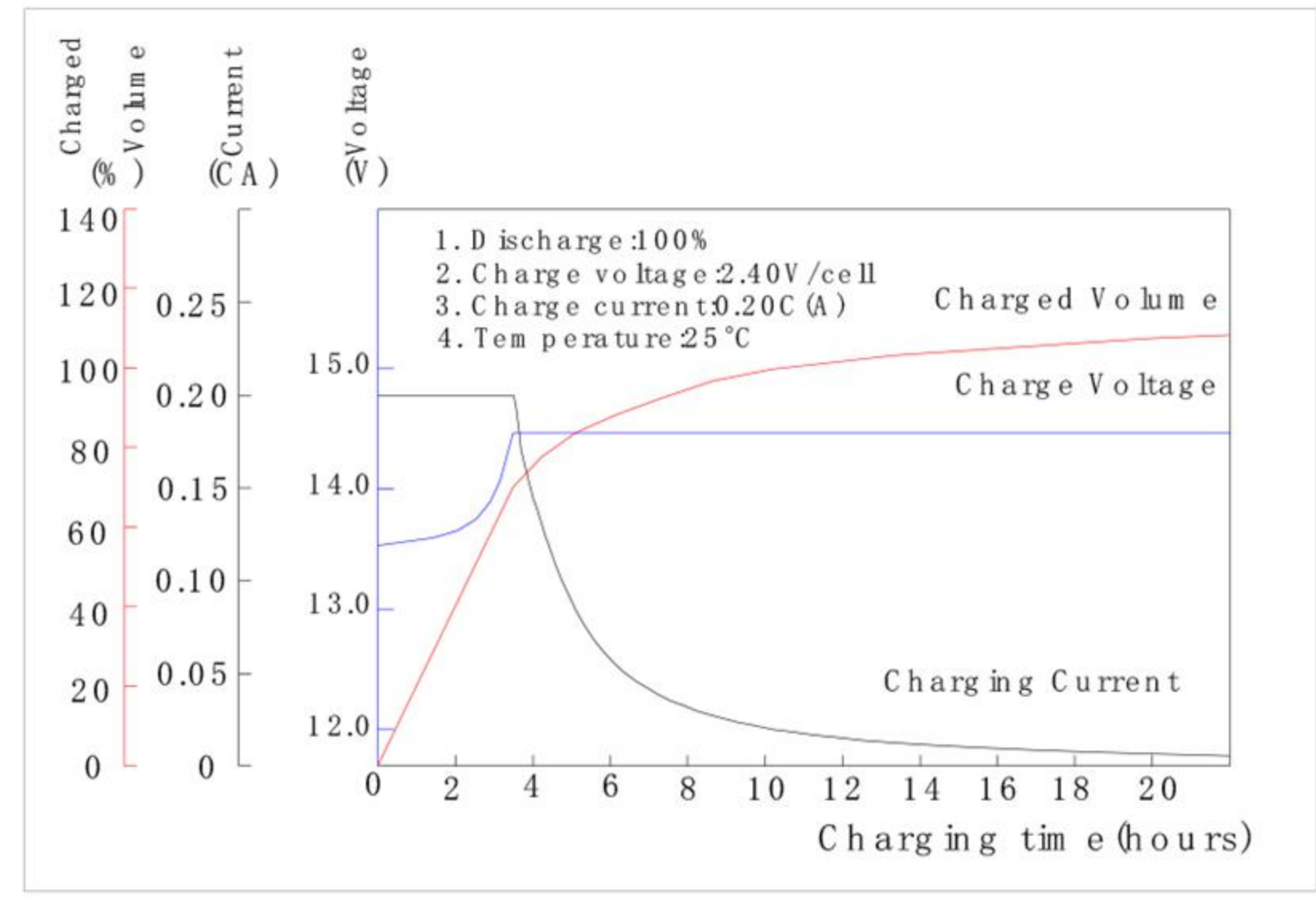

### Effect of Temperature on Capacity

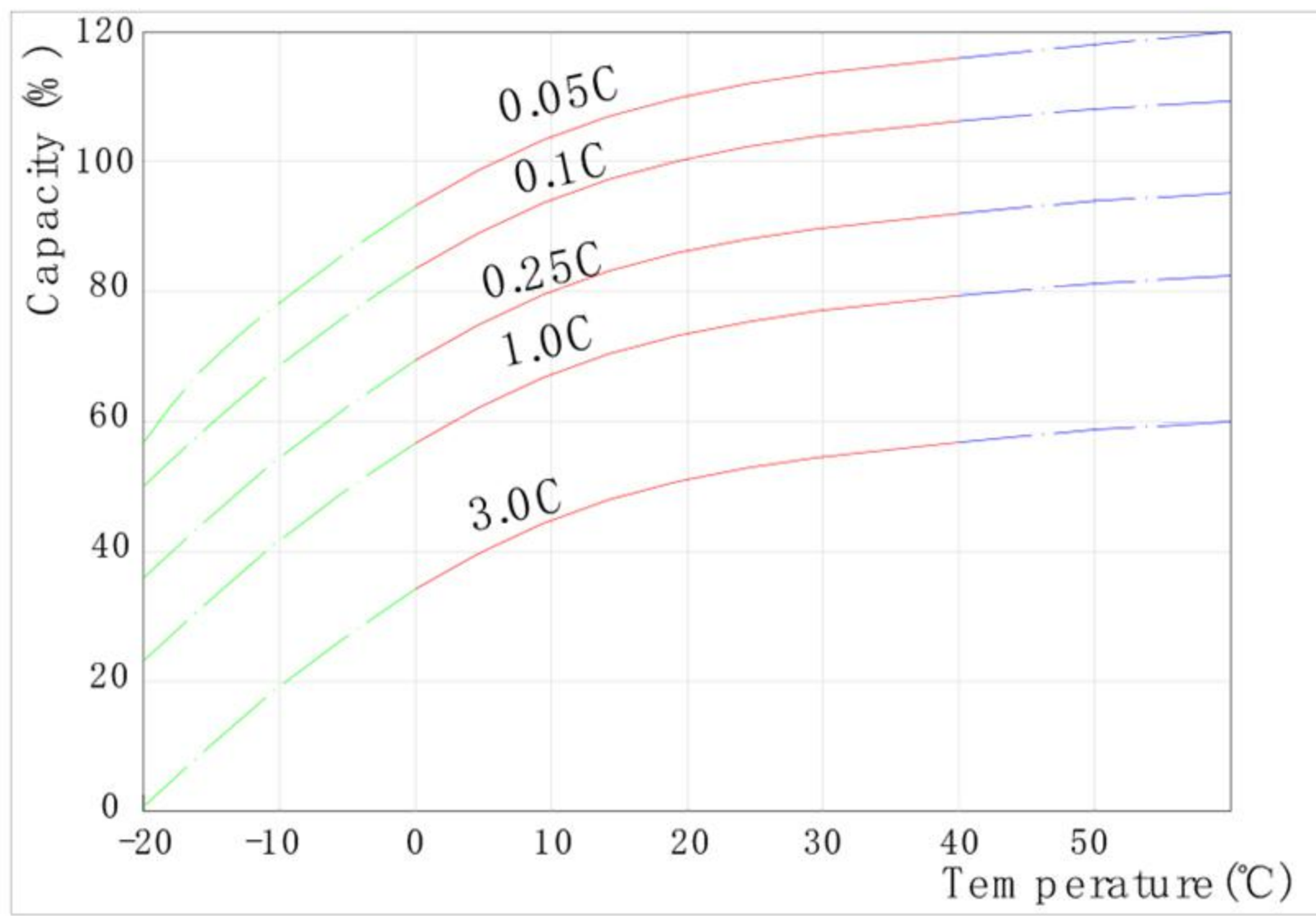

### Self-discharge Characteristics

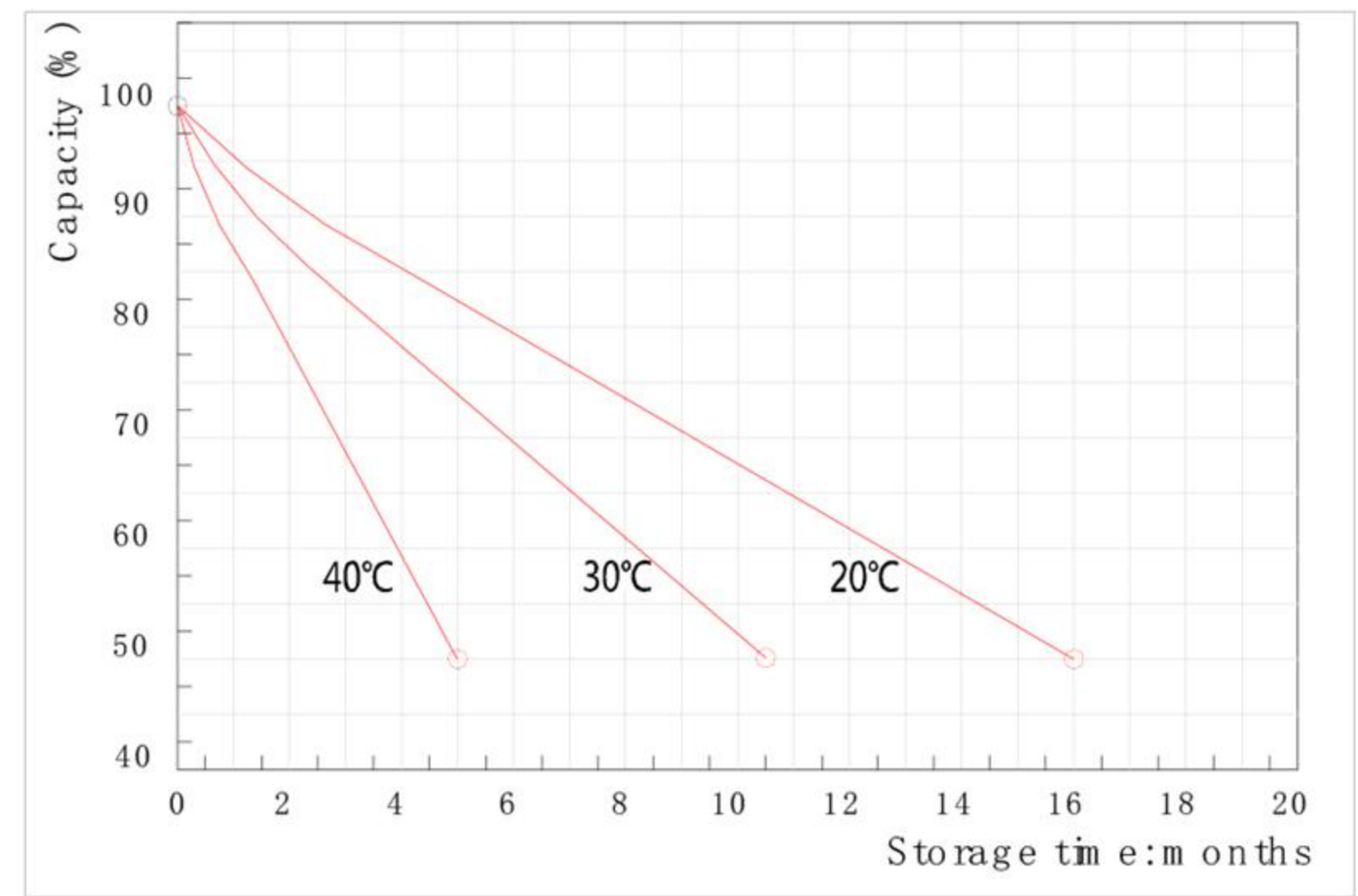

### The Relationship for Open Circuit Voltage and Residual Capacity (25°C)

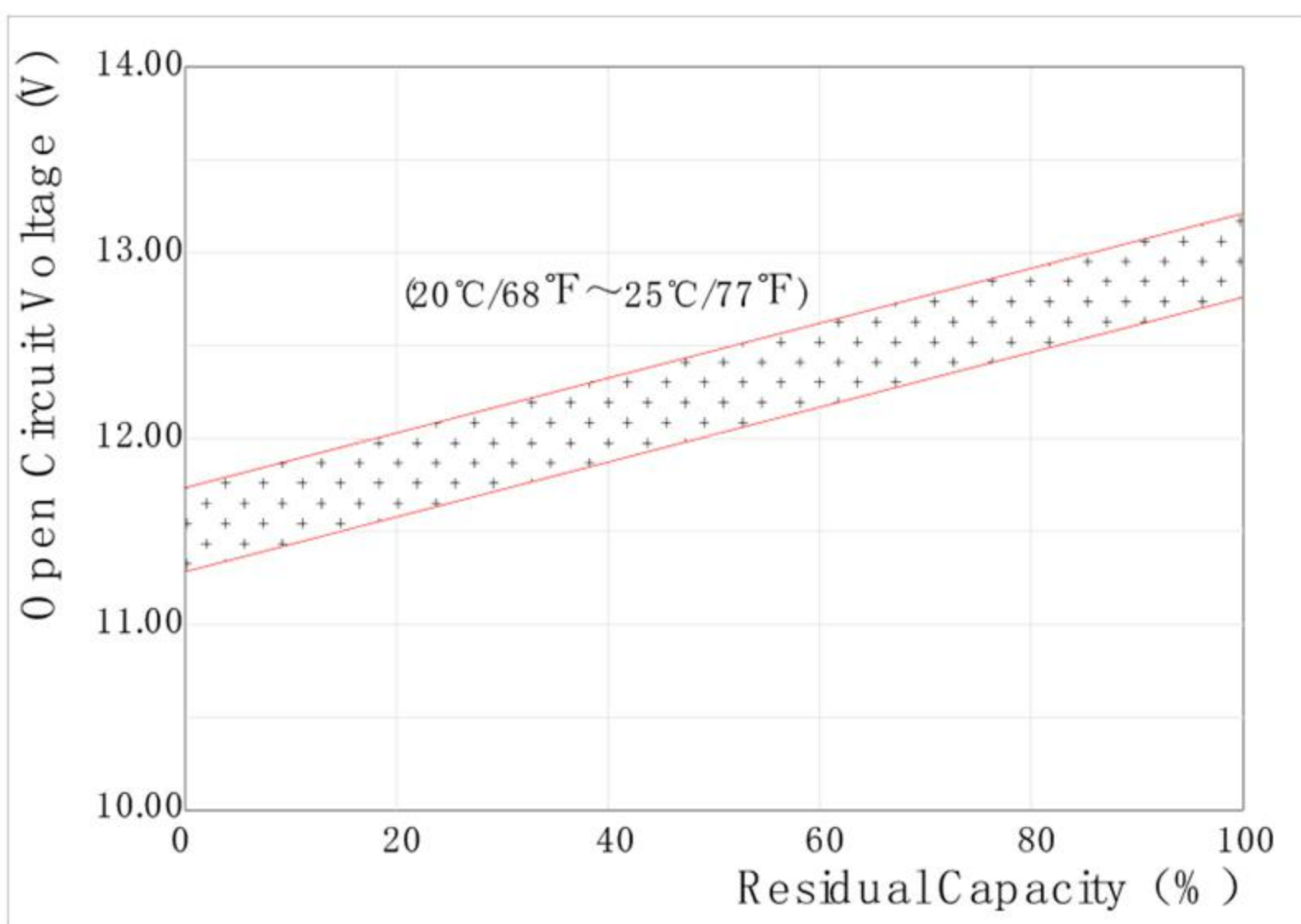

### The Relationship for Charging Voltage and Temperature

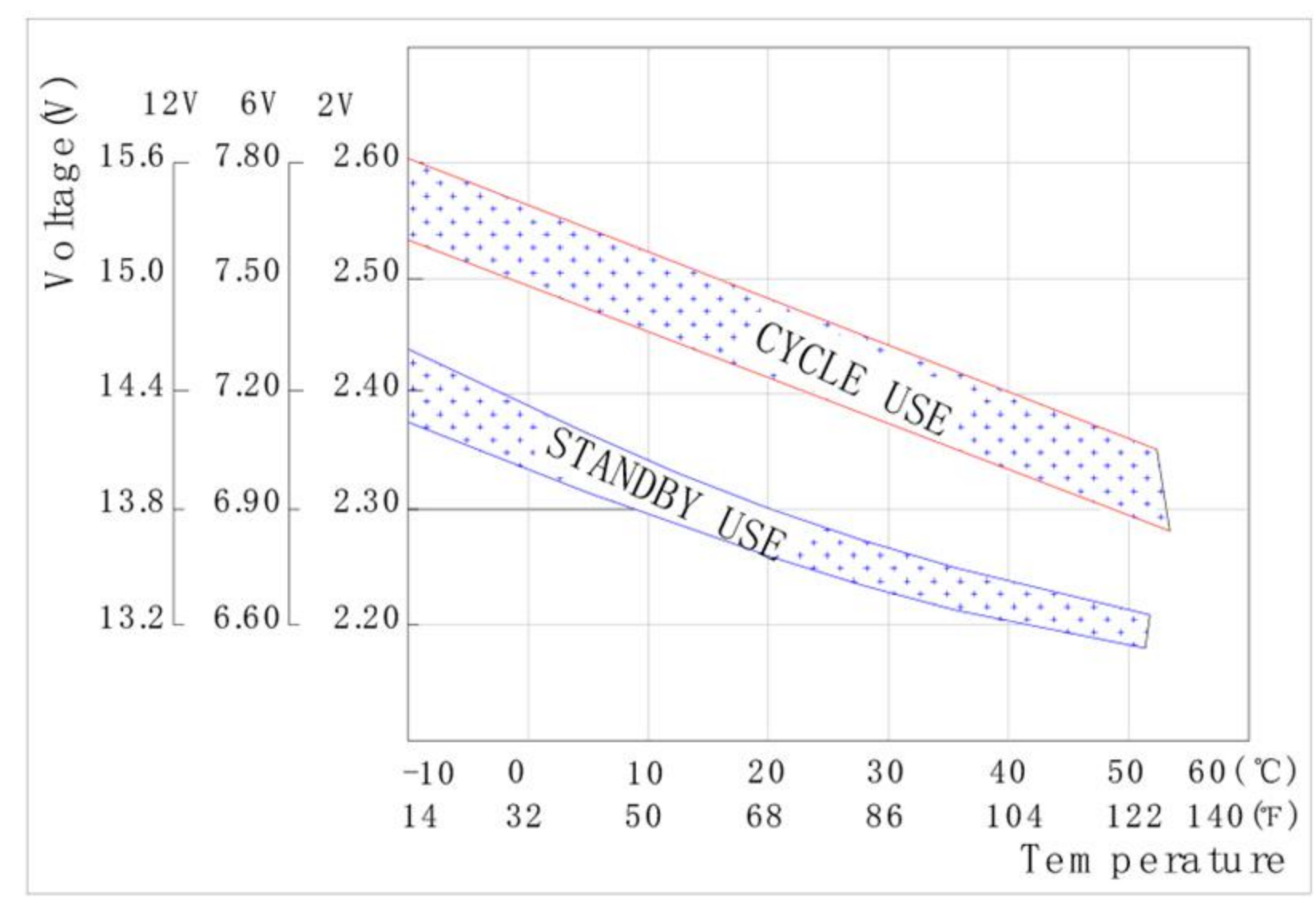

### Floating Life on Temperature

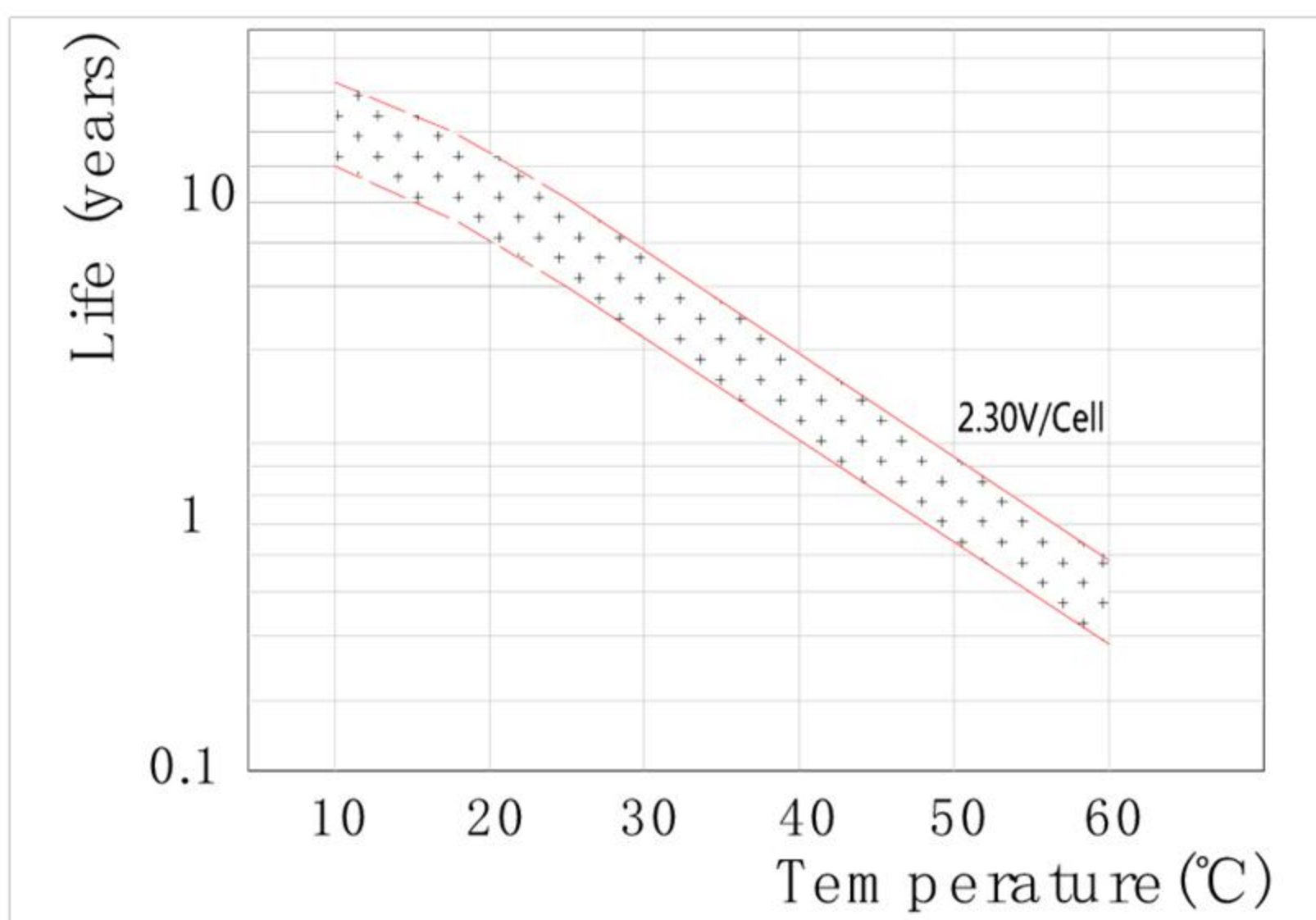

### Cycle Life on D.O.D(25°C)

